



**Model DYN-IS-40
40 N Inertial Shaker
Product Manual**

Product Support

If at any time you have questions or problems with the DYN-IS-40 shaker, please contact a Dynalabs engineer at:

Phone: +90 312 266 33 34 (9 a.m. to 5 p.m., UTC +3)

e-mail: info@dynalabs.com.tr

Warranty

Our products are warranted against defective materials and workmanship for one year. Defects arising from user errors are not covered by the warranty.

Copyright

All copyrights of this manual belonging to DynaLabs products are reserved. It cannot be reproduced without written consent.

Disclaimer

Dynalabs Ltd. provides this publication "as is" without warranty of any kind, express or implied, including but not limited to, the implied warranties of merchantability or fitness for a particular purpose. This document is subject to change without notice, and should not be construed as a commitment or representation by DynaLabs.

This publication may contain inaccuracies or typographical errors DynaLabs will periodically update the material for inclusion in new editions. Changes and improvements to the product described in this manual may be made at any time.

Table of Contents

1) Introduction	4
2) General Information	4
2.1) Unpacking and Inspection	4
2.2) System Components	4
2.3) Theory of Operation	5
2.4) Specifications.....	6
2.5) Outline Drawing.....	7
3) Operation and Installation.....	8
3.1) General.....	8
3.1.1-) External Signal Mode:.....	8
3.1.2-) Internal Signal Mode:.....	9
3.2) Power Requirements.....	10
3.3) Cooling.....	10
3.4) Frequency Response	10
3.5) Mounting Interface	11
4) Maintenance and Troubleshooting.....	11
5) Safety.....	11
5.1) Grounding.....	12
6) Declaration of Conformity	13

1) Introduction

The inertial shaker (DYN-IS-40) is used for relatively small structures requiring excitation in low frequency bands. The shaker is directly connected to the structure and the inertia motion of the shaker mass provides the necessary forces to the structure. The shaker has a small, lightweight design that provides high mobility. For this reason, it is suitable for use as a portable shaker.

2) General Information

2.1) Unpacking and Inspection

DynaLabs products provide adequate protection for undamaged products to be transported. Document the damages that occur indirectly during the transport and contact the customer representative. Check all components of the shaker. If there is a defect, please contact us.

2.2) System Components

DYN-IS-40 has the following components:

- Electrodynamic Shaker Body
- Amplifier (DYN-SA-150)
- Power Adapter
- Signal Cable
- Sensor Mounting Adapter
- Stainless Bolt For Mounting(M3X60)
- User Manual

2.3) Theory of Operation

DYN-IS-40 is an electromagnetic actuator. Electromagnetic actuators are basically a voice coil consisting of magnet and coil. The moving element can be a coil or magnet depending on the design requirements. The moving element is usually suspended by an elastic spring. DYN-IS-40 has a stationary coil (drive coil) whose current is controlled to produce vibration. The stationary magnetic field is produced by a magnet.

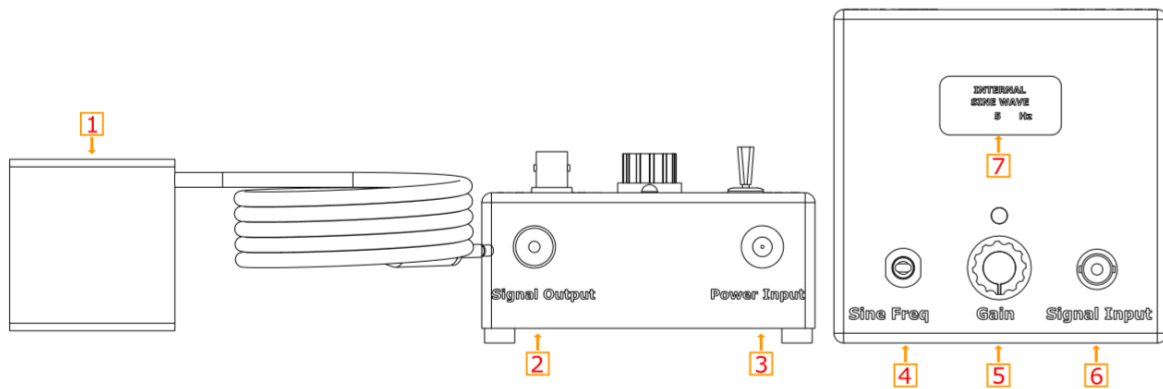

Item	Description
1	Shaker Body (Integrated Cable)
2	Signal Output
3	DC Power Input
4	Sine Freq
5	Gain Knob
6	External Signal Input
7	LCD Display

2.4) Specifications

Parameters	Specifications
Excitation Type	Vertical or Horizontal
Output Force (Sinus)	40 N
Frequency	10-3000 Hz
Displacement (Peak to Peak)	8 mm
Moving Mass	0.16 kg
Shaker Weight	0.5 kg
Suspension	Spring
Cooling System	Natural Convection
Operating Temperature Range	5-35 °C
Maximum Input Current	4A (RMS)
AMPLIFIER	EXTERNAL
Amplifier Weight	0.65 kg
Power Supply Voltage	24V DC
Power Supply Current	5 A
External Signal Voltage Level	1 VAC(PEAK)

2.5) Outline Drawing

The dimensional properties of DYN-IS-40 shakers are given below. All dimensions are in mm's.

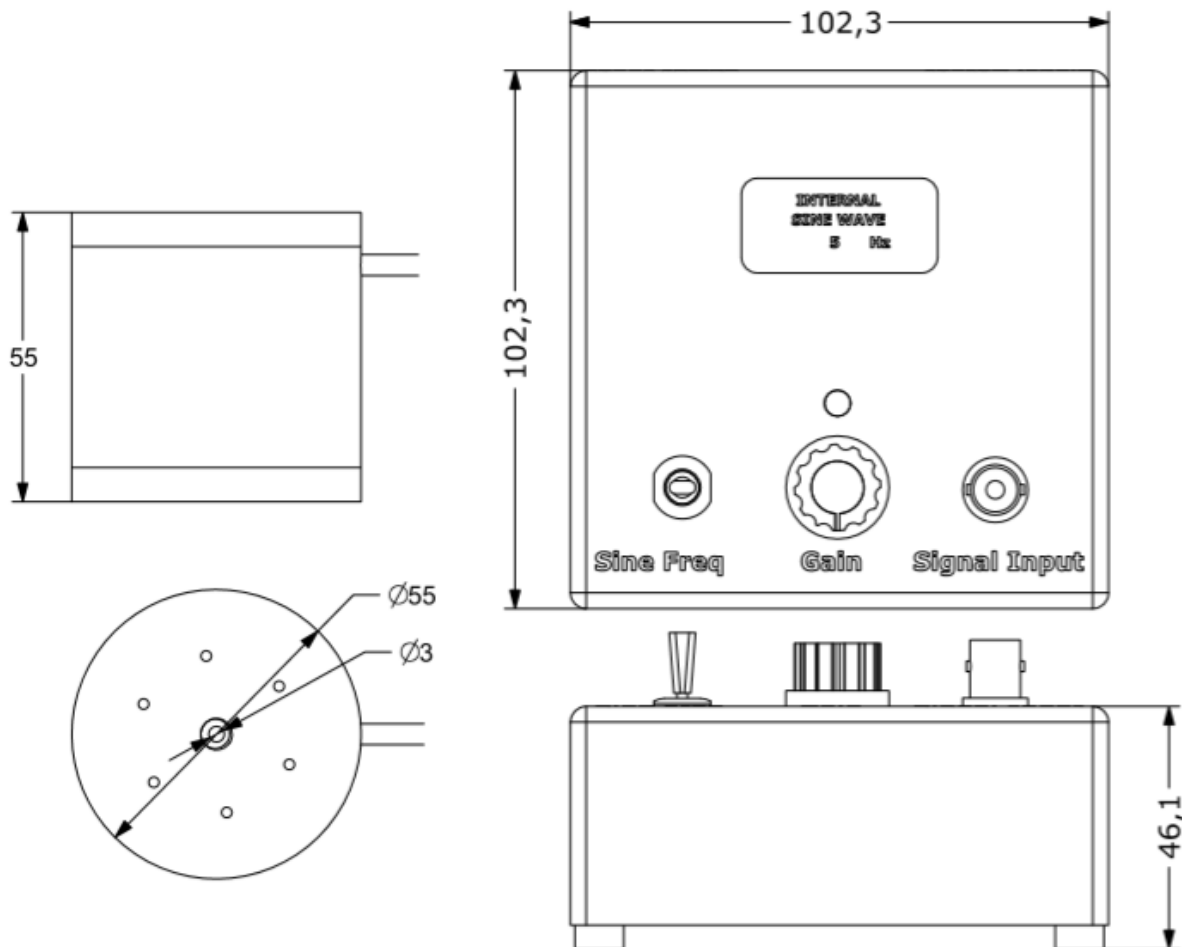

3) Operation and Installation

3.1) General

The general shaker connector configuration is given below.

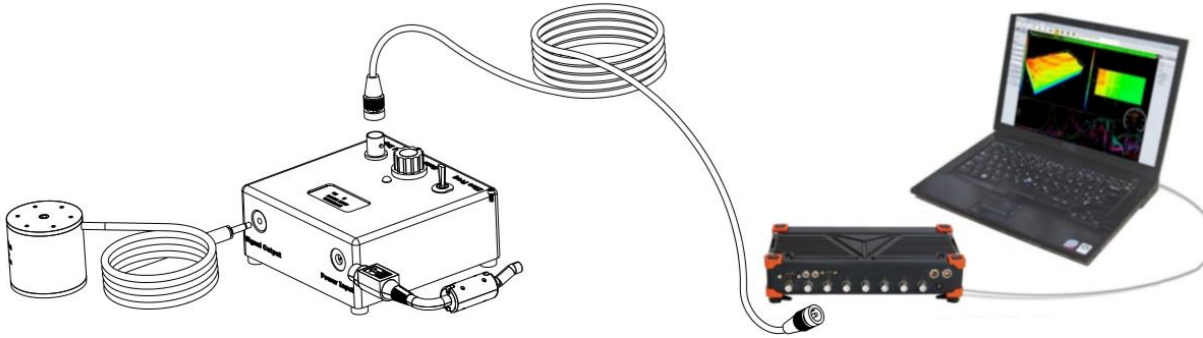

The Gain Knob is a push-pull and rotational switch. The amplifier is in External Signal Mode when the Gain Knob is pushed in and the amplifier is in Internal Signal Mode when it is pulled out.

In order to protect the amplifier from electrical problems, it is advised to turn the Gain Knob counter clockwise to the lowest gain position before connecting the external signal cable or before changing operational modes.

3.1.1-) External Signal Mode:

Connect DC power source and drive signal to shaker power input and signal input respectively. Start the external signal source. Adjust the Gain of the amplifier by turning the Gain Knob clockwise.

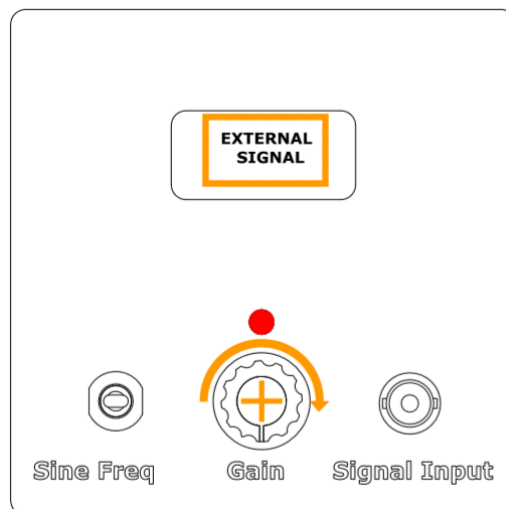

3.1.2-) Internal Signal Mode:

The amplifier can generate sine signal from 1Hz to 15kHz with 1 Hz increments that the user can adjust with the Sine Frequency Generator Switch. Connect DC power source and drive signal to shaker power input. Pull the Gain Knob out.

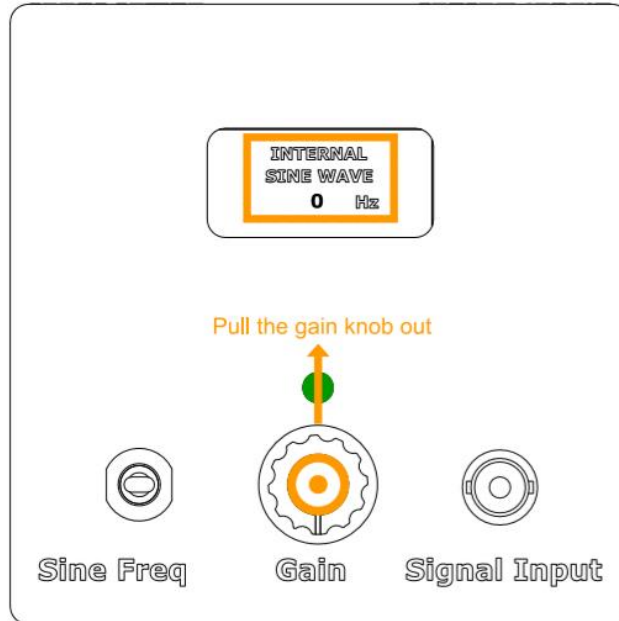

Raise or lower the Sine Frequency Generator Switch to the desired Sine frequency. Adjust the Gain of the amplifier by turning the Gain Knob clockwise. The frequency of the generated sine signal will be visible on the LCD Screen.

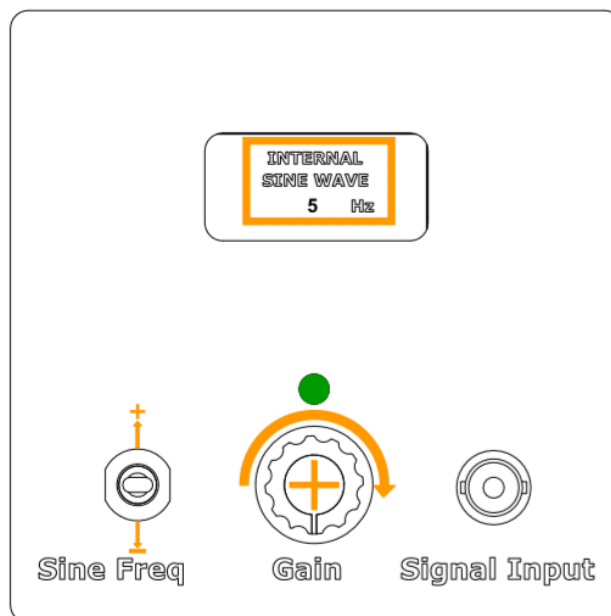

3.2) Power Requirements

DYN-IS-40 has an external power amplifier which is powered by its power adaptor. Please note the output voltage and current ratings of the adaptor if a replacement adaptor is to be used.

3.3) Cooling

DYN-IS-40 does not require forced cooling. Air convection cooling is sufficient for the force levels given in the specifications.

3.4) Frequency Response

The DYN-IS-40 has a relatively flat force response of 40N. The following figure shows the Force (Newton) over applied Voltage (Volt) frequency response of DYN-IS-40.

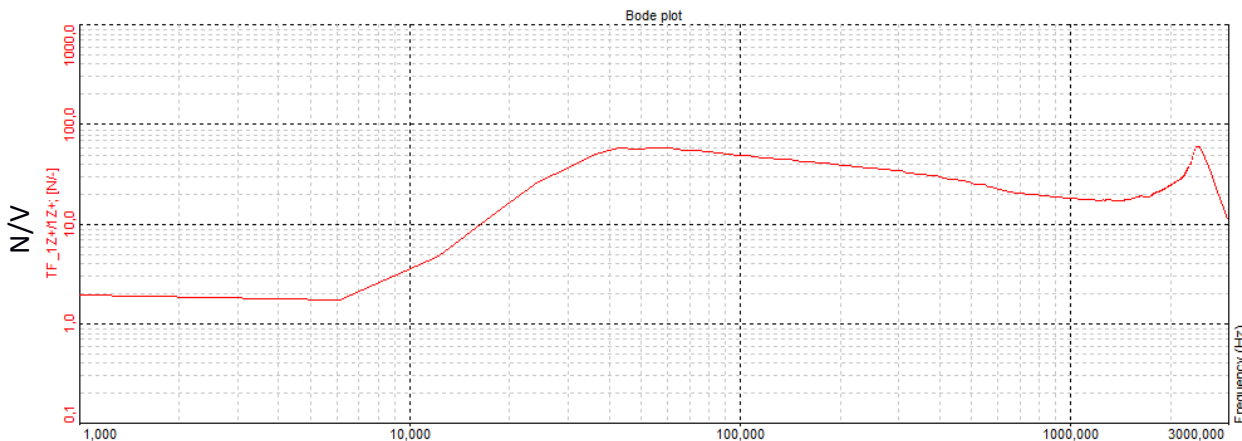

FOR FIXED FREQUENCY SINE TESTING, APPLICATION OF VOLTAGE LEVELS ABOVE 1V FOR LONG DURATIONS (>1MIN) CAN PERMANENTLY DAMAGE THE SHAKER.

THE SHAKER SUSPENSION NATURAL FREQUENCY IS ABOUT 40 HZ. ESPECIALLY FOR FIXED FREQUENCY SINE TESTING, THE USER SHOULD ALWAYS LOWER THE GAIN FOR THE FREQUENCY BAND OF 5-50 HZ. OTHERWISE, DUE TO THE HIGH RESPONSE OF THE SHAKER AROUND ITS RESONANCE FREQUENCY, VERY HIGH AMPLITUDES OF VIBRATION (~120N) WILL OCCUR AND PERMANENTLY DAMAGE THE SHAKER.

THE INTERNAL SINE SIGNAL GENERATOR SUPPLIES A CONSTANT VOLTAGE OF 1VAC. PLEASE LOWER THE GAIN IN THE VICINITY OF THE NATURAL FREQUENCY AS HIGHLIGHTED ABOVE.

3.5) Mounting Interface

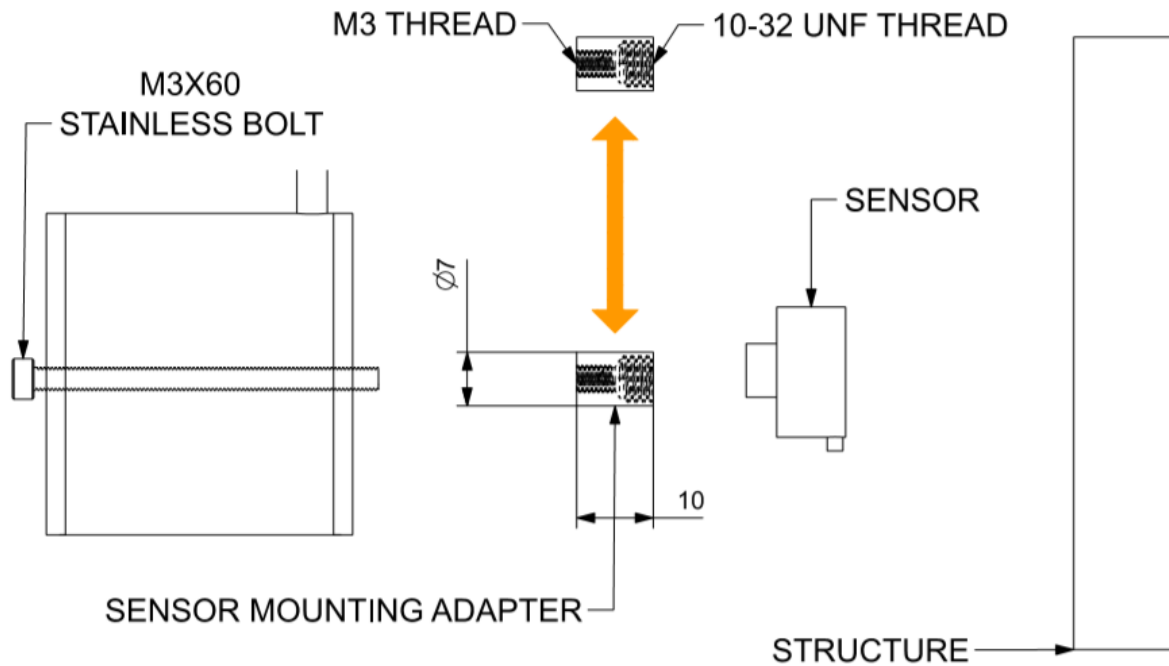

4) Maintenance and Troubleshooting

The DYN-IS-40 shaker is a sealed device requiring no maintenance if the operating instructions described in this manual are followed. Repair of the coil, exciter body or magnet core should not be attempted. Please return the shaker to DynaLabs for proper repair.

5) Safety

Please ensure that this manual section is reviewed and understood prior to installation, operation or maintenance of the equipment. The danger of electrical shock or fire always exists in electrical equipment.

The DYN-IS-40 Inertial Shaker is designed for safe operation. Safety features such as electrical insulation on outer surfaces are provided for the safe operation of the shaker system. Always monitor the applied voltage to the amplifier and shut down the shaker if the temperature of the shaker body rises drastically or smoke is observed from the shaker due to high voltage levels applied.

5.1) Grounding

The shaker is internally grounded via the power adapter. However, if further grounding is necessary a grounding socket is available on the shaker as shown. Appropriate grounding cable is also supplied with the shaker.

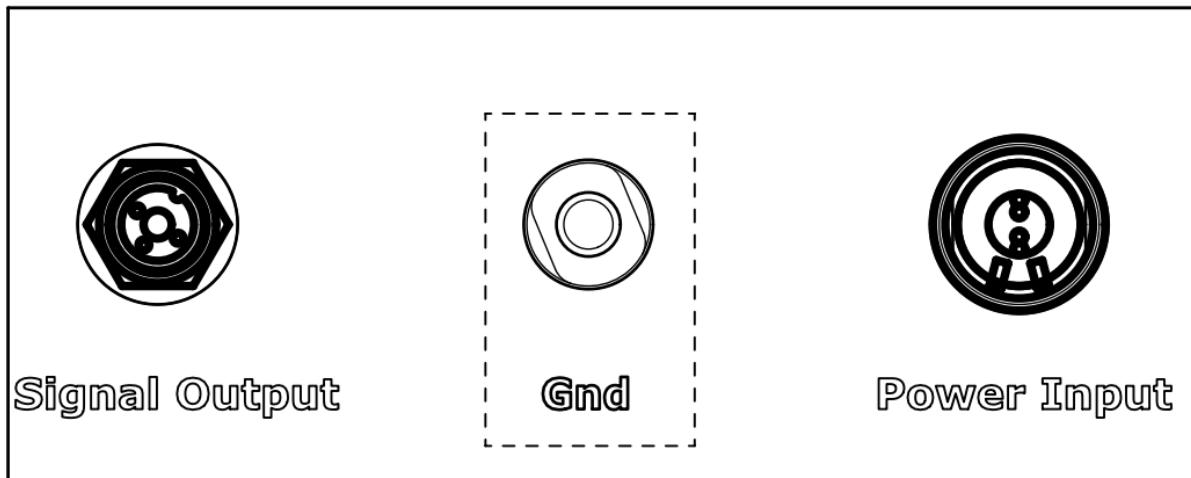

6) Declaration of Conformity

DynaLabs



*This declaration of conformity is issued under the sole responsibility of the manufacturer.
The product(s) are developed, produced and tested according to following EC- directives:*

- 2014/35/EU – Low Voltage Directive (LVD)
- 2006/42/EU – Machinery Safety Directive
- 2015/863/EU – RoHS Directive

Applied standards:

- EN 61010-1:2010
- EN ISO 12100:2010
- MIL-STD-810-H-2019 (Test Methods: 501.7 - High Temperature, 502.7 - Low Temperature, 514.8 - Vibration, 516.8 – Shock)

*DYNALABSMÜHENDİSLİK SANAYİ TİCARET LİMİTED ŞİRKETİ declares
that above mentioned products meet all the requirements of the above mentioned
standards and regulations.*

Murat Aykan, Technical Manager

Ankara, 15.07.2021